

Part number:

HYDROMA

HYDRAULICKÉ SYSTÉMY

**HIDROMA
SISTEMS**

UKŁADY HYDRAULICZNE

HYDROMA

ГИДРАВЛИЧЕСКИЕ СИСТЕМЫ

GHP3

COME ORDINARE / HOW TO ORDER

GHP3	TIPO TYPE	ROTAZIONE ROTATION	TAGLIA SIZE	ALBERO* SHAFT*	PORTE* PORTS*	GUARNIZIONI* SEALS*	OPZIONI* OPTIONS*	DRENAGGIO* DRAIN*
	omit	D DESTRA CLOCKWISE	30					
	A	S SINISTRA COUNTER CLOCKWISE	33					
	A2		40					
	BK1	R** REVERSIBILE REVERSIBLE	50					
	5		60					
			66					
			80					
			94					
			110					
			120					
			135					

Guarnizioni / Seals
omit (T range = -10°C + 80°C)
V
H
...

Opzioni / Options
TR
...

**Drenaggio (solo per rotazione R)
Drain (only for R rotation)**
E0 = drenaggio interno/internal drain
E1 = drenaggio esterno/external drain G3/8
***E2 = drenaggio esterno/external drain 3/4-16 UNF
E3 = drenaggio esterno/external drain G1/4
***E4 = drenaggio esterno/external drain 9/16-18 UNF

(*) = campi da specificare se diversi dallo standard "tipo pompa" / to be specified if different from standard pump type
(**) = La rotazione reversibile R è disponibile per tutte le taglie indicate / R rotation is available for all listed displacements
(***) = Porte di drenaggio lavorate secondo la specifica SAE J1926/1 (ISO 11926-1) relativa a porte filettate con tenuta O-ring. / Drain ports are machined in compliance with threaded port with O-ring seal in truncated housing SAE J1926/1 (ISO 11926-1).

Tipi Pompa Standard / Pump Standard Types

omit	= flangia europea + albero T0 + porte E + guarnizioni standard / european flange + shaft T0 + ports E + standard seals
A	= flangia A + albero C1 + porte A + guarnizioni standard / flange A + shaft C1 + ports A + standard seals
A2	= flangia A2 + albero C1 + porte A + guarnizioni standard / flange A2 + shaft C1 + ports A + standard seals
BK1	= flangia BK1 + albero T1 + porte D + guarnizioni standard / flange BK1 + shaft T1 + ports D + standard seals
5	= flangia 5 + albero T2 + porte E + guarnizioni standard / flange 5 + shaft T2 + ports E + standard seals

Esempi / Examples:

GHP3-D-30	= pompa destra, 20 cc/rev, flangia europea, albero conico 1:8, porte flangiate tipo E, guarnizioni standard rotation, 20 cc/rev, european flange, 1:8 tapered shaft, flanged ports E type, standard seals
GHP3-D-30-CO	= pompa destra, 20 cc/rev, flangia europea, albero cilindrico (CO), porte flangiate tipo E, guarnizioni standard clockwise rotation, 20 cc/rev, european flange, cylindrical shaft (CO), flanged ports E type, standard seals
GHP3A-D-30-E	= pompa destra, 20 cc/rev, flangia SAE B-2 fori, albero cilindrico, porte flangiate (E), guarnizioni standard clockwise rotation, 20 cc/rev, SAE B 2 bolt flange, cylindrical shaft, european flanged ports (E), standard seals

LE TAVOLE DI PRODOTTO RAPPRESENTANO I TIPI POMPA STANDARD PER MARZOCCHI POMPE. LE TAVOLE SINOTTICHE DI FLANGE, ALBERI E PORTE HANNO LO SCOPO DI RAPPRESENTARE TUTTE LE POSSIBILI CONFIGURAZIONI DI PRODOTTO. PER MAGGIORI DETTAGLI SULLE DISPONIBILITÀ E CONDIZIONI DI FORNITURA, CONSIGLIAMO DI INTERPELLARE IL NOSTRO UFFICIO TECNICO-COMMERCIALE.

THE PRODUCT DATA SHEETS SHOW OUR STANDARD MODEL TYPES. THE SYNOPTIC TABLES FOR FLANGES, SHAFTS AND PORTS SHOW ALL THE POSSIBLE CONFIGURATIONS. FOR FURTHER DETAILS ABOUT THE AVAILABILITY OF EACH CONFIGURATION PLEASE CONTACT OUR SALES AND TECHNICAL DEPT.

GHP3

Parti accessorie a corredo della pompa standard: linguetta a disco (codice 522058), dado M14x1.5 (codice 523017), rosetta elastica spaccata (codice 523006).
 Porte standard: filetti M10 profondità utile 19 mm.

Accessories supplied with the standard pump: woodruff key (code 522058), M14x1.5 hexagonal nut (code 523017), washer (code 523006).
 Standard ports: M10 threads depth 19 mm.

MANDATA
 OUTLET

ASPIRAZIONE
 INLET

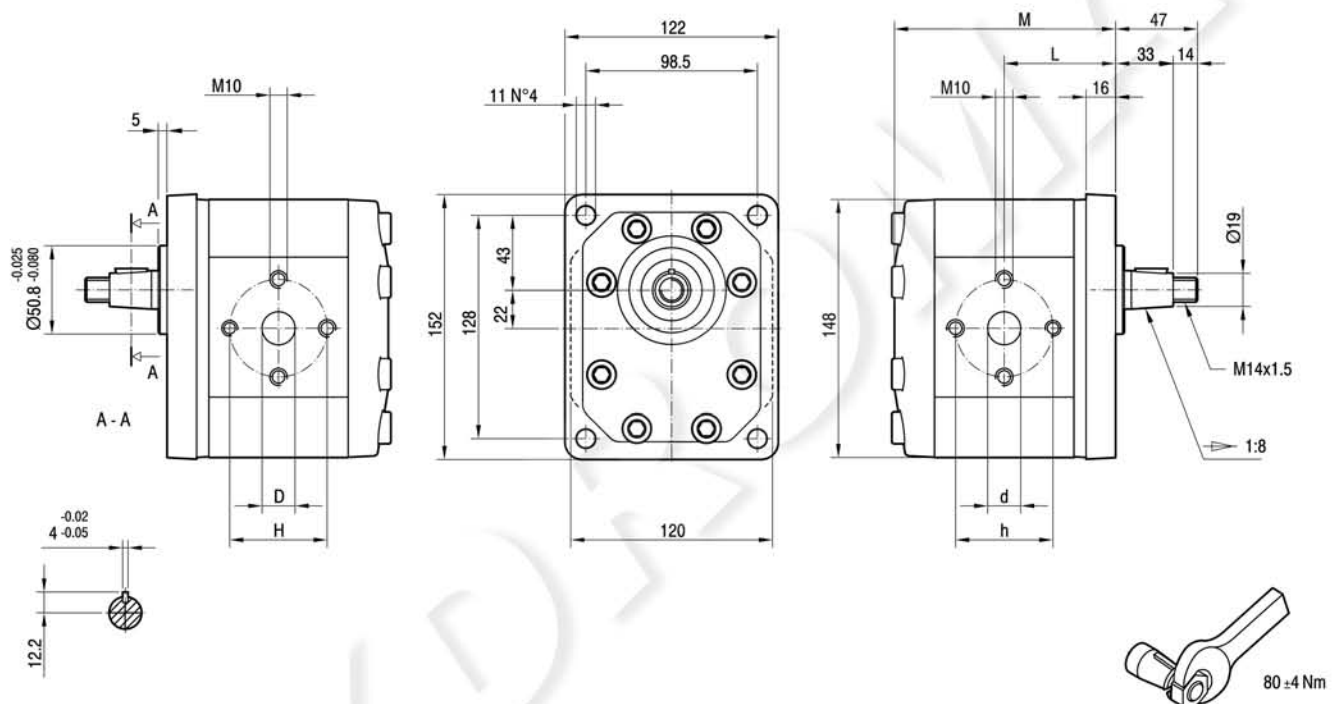

TIPO TYPE	CILINDRATA DISPLACEMENT	PORTATA a 1500 giri/min FLOW at 1500 rev/min	PRESSIONI MASSIME MAX PRESSURE			VELOCITÀ MASSIMA MAX SPEED	DIMENSIONI DIMENSIONS					
			P ₁	P ₂	P ₃		L	M	d	D	h	H
	cm ³ /giro [cm ³ /rev]	litri/min [litres/min]	bar	bar	bar	giri/min [rpm]	mm	mm	mm	mm	mm	mm
GHP3-D-30	20	29	280	295	310	3500	64	127	27	19	56	56
GHP3-D-33	22	31	280	295	310	3500	64,5	128	27	19	56	56
GHP3-D-40	26	37	280	295	310	3000	66	131	27	19	56	56
GHP3-D-50	33	48	270	285	300	3000	68,5	136	27	19	56	56
GHP3-D-60	39	56	260	275	290	3000	70,5	140	27	19	56	56
GHP3-D-66	44	62	250	265	280	2800	72	143	27	27	51	51
GHP3-D-80	52	74	230	245	260	2400	75	149	27	27	56	56
GHP3-D-94	61	87	210	225	240	2800	78	155	33	27	62	51
GHP3-D-110	71	101	200	215	230	2500	81,5	162	33	27	62	51
GHP3-D-120	78	112	180	195	210	2300	84	167	33	27	62	51
GHP3-D-135	87	124	160	175	190	2000	87	173	33	27	62	51

GHP3

FLANGE / FLANGES

ALBERI / SHAFTS

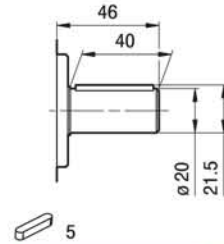
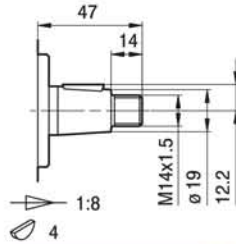
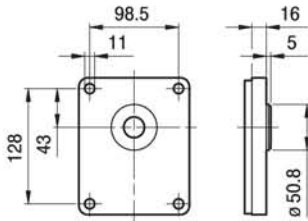

T0

C0

Coppia Max
Max Torque 280 Nm

Coppia Max
Max Torque 265 Nm

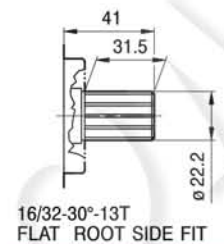
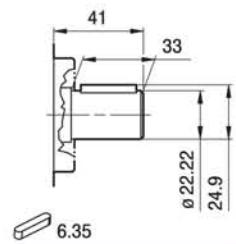
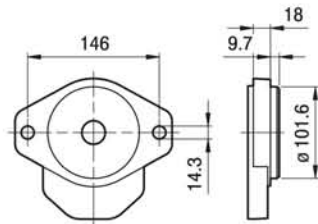

16/32-30°-13T
FLAT ROOT SIDE FIT

C1

S1

Coppia Max
Max Torque 295 Nm

Coppia Max
Max Torque 405 Nm

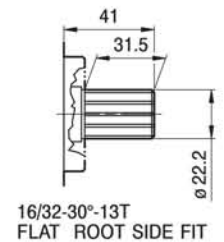
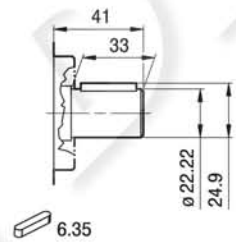
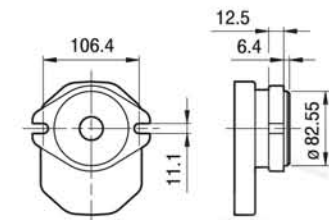

16/32-30°-13T
FLAT ROOT SIDE FIT

C1

S1

Coppia Max
Max Torque 295 Nm

Coppia Max
Max Torque 405 Nm

GHP3

FLANGE / FLANGES

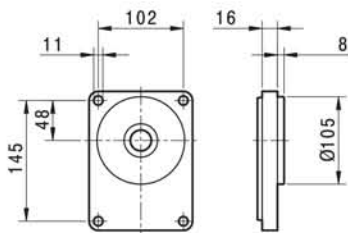

BK1

ALBERI / SHAFTS

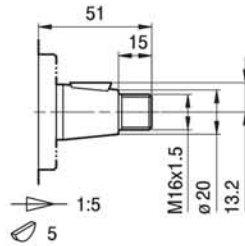

T1

Coppia Max
Max Torque 285 Nm

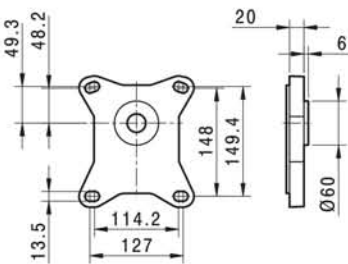

5

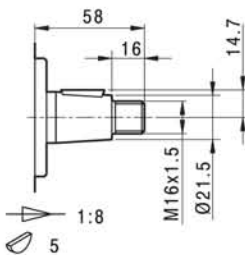

T2

Coppia Max
Max Torque 325 Nm

GHP3

PORTE / PORTS

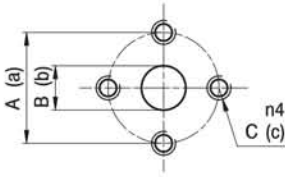

FE

TIPO TYPE	ASPIRAZIONE INLET			MANDATA OUTLET		
	A	B	C	a	b	c
GHP3...30 ÷ GHP3...60	56	27	M10	56	19	M10
GHP3...66	51	27	M10	51	27	M10
GHP3...80	56	27	M10	56	27	M10
GHP3...94 ÷ GHP3...135	62	33	M10	51	27	M10

I valori delle coppie di serraggio delle viti presenti nel kit raccordo sono indicate a pag 55 (capitolo accessori).
Tightening torques of the fittings screws are specified on page 55 (accessories section).

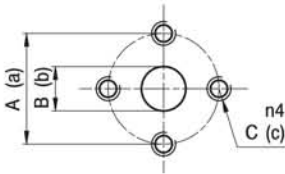

EP

TIPO TYPE	ASPIRAZIONE INLET			MANDATA OUTLET		
	A	B	C	a	b	c
GHP3...30 ÷ GHP3...33	40	19	M8	40	19	M8
GHP3...40 ÷ GHP3...80	51	27	M10	40	19	M8

I valori delle coppie di serraggio delle viti presenti nel kit raccordo sono indicate a pag 55 (capitolo accessori).
Tightening torques of the fittings screws are specified on page 55 (accessories section).

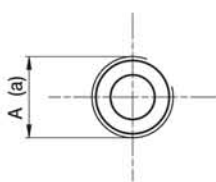

FG

TIPO TYPE	ASPIRAZIONE INLET	MANDATA OUTLET
	A	a
GHP3...30 ÷ GHP3...33	G3/4	G3/4
GHP3...40 ÷ GHP3...60	G1	G3/4
GHP3...66 ÷ GHP3...94	G1 1/4	G1
GHP3...110 ÷ GHP3...135	G1 1/2	G1 1/4

Raccordo G3/4 coppia di serraggio massima 60 Nm. Raccordo G1 coppia di serraggio massima 70 Nm. Raccordo G1 1/4 coppia di serraggio massima 80 Nm. Raccordo G1 1/2 coppia di serraggio massima 90 Nm. Consigliamo di richiedere conferma al fornitore del raccordo.

Tightening torques for G3/4 fitting: 60 Nm. Tightening torques for G1 fitting: 70 Nm. Tightening torques for G1 1/4 fitting: 80 Nm. Tightening torques for G1 1/2 fitting: 90 Nm. Please check with the fittings suppliers.

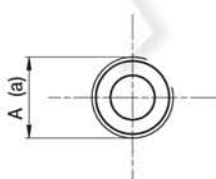

FC

TIPO TYPE	ASPIRAZIONE INLET	MANDATA OUTLET
	A	a
GHP3...30 ÷ GHP3...33	Rc3/4	Rc3/4
GHP3...40 ÷ GHP3...60	Rc1	Rc3/4
GHP3...66 ÷ GHP3...94	Rc1 1/4	Rc1
GHP3...110 ÷ GHP3...135	Rc1 1/2	Rc1 1/4

Raccordo Rc3/4 coppia di serraggio massima 60 Nm. Raccordo Rc1 coppia di serraggio massima 70 Nm. Raccordo Rc1 1/4 coppia di serraggio massima 80 Nm. Raccordo Rc1 1/2 coppia di serraggio massima 90 Nm. Consigliamo di richiedere conferma al fornitore del raccordo.

Tightening torques for Rc3/4 fitting: 60 Nm. Tightening torques for Rc1 fitting: 70 Nm. Tightening torques for Rc1 1/4 fitting: 80 Nm. Tightening torques for Rc1 1/2 fitting: 90 Nm. Please check with the fittings suppliers.

Nel caso di funzionamento a pressioni elevate e intermittenti è possibile una riduzione della resistenza a fatica del corpo.
A reduction of body's fatigue strength may occur if the pump is working at elevated and intermittent pressures.

GHP3

PORTE / PORTS

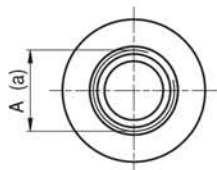

STANDARD SAE J1926/1

FA

TIPO TYPE	ASPIRAZIONE INLET	MANDATA OUTLET
	A	a
GHP3...30 ÷ GHP3...50	1 5/16-12 UNF	1 1/16-12 UNF
GHP3...60 ÷ GHP3...80	1 5/8-12 UNF	1 1/16-12 UNF
GHP3...94 ÷ GHP3...135	1 7/8-12 UNF	1 5/16-12 UNF

Raccordo 1 1/16-12 UNF coppia di serraggio massima 70 Nm. Raccordo 1 5/16-12 UNF coppia di serraggio massima 80 Nm. Raccordo 1 5/8-12 UNF coppia di serraggio massima 80 Nm. Raccordo 1 7/8-12 UNF coppia di serraggio massima 80 Nm. Consigliamo di richiedere conferma al fornitore del raccordo.

Tightening torques for 1 1/16-12 UNF fitting: 70 Nm. Tightening torques for 1 5/16-12 UNF fitting: 80 Nm. Tightening torques for 1 5/8-12 UNF fitting: 80 Nm. Tightening torques for 1 7/8-12 UNF fitting: 80 Nm. Please check with the fittings suppliers.

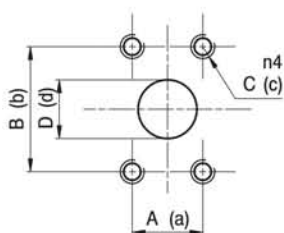

A

TIPO TYPE	ASPIRAZIONE INLET				MANDATA OUTLET			
	A	B	C	D	a	b	c	d
GHP3...30 ÷ GHP3...80	26,19	52,37	3/8-16 UNC	27	22,23	47,63	3/8-16 UNC	19
GHP3...94 ÷ GHP3...135	30,2	58,7	7/16-14 UNC	33	26,19	52,37	3/8-16 UNC	27

I valori delle coppie di serraggio delle viti presenti nel kit raccordo sono indicate a pag 55 (capitolo accessori).

Tightening torques of the fittings screws are specified on page 55 (accessories section).

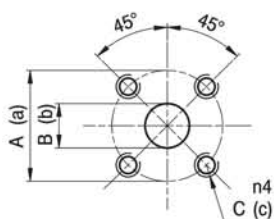

D

TIPO TYPE	ASPIRAZIONE INLET			MANDATA OUTLET		
	A	B	C	a	b	c
GHP3...30 ÷ GHP3...80	55	27	M8	55	19	M8

I valori delle coppie di serraggio delle viti presenti nel kit raccordo sono indicate a pag 55 (capitolo accessori).

Tightening torques of the fittings screws are specified on page 55 (accessories section).



GHP3 CURVE CARATTERISTICHE

GHP3 PERFORMANCE CURVES

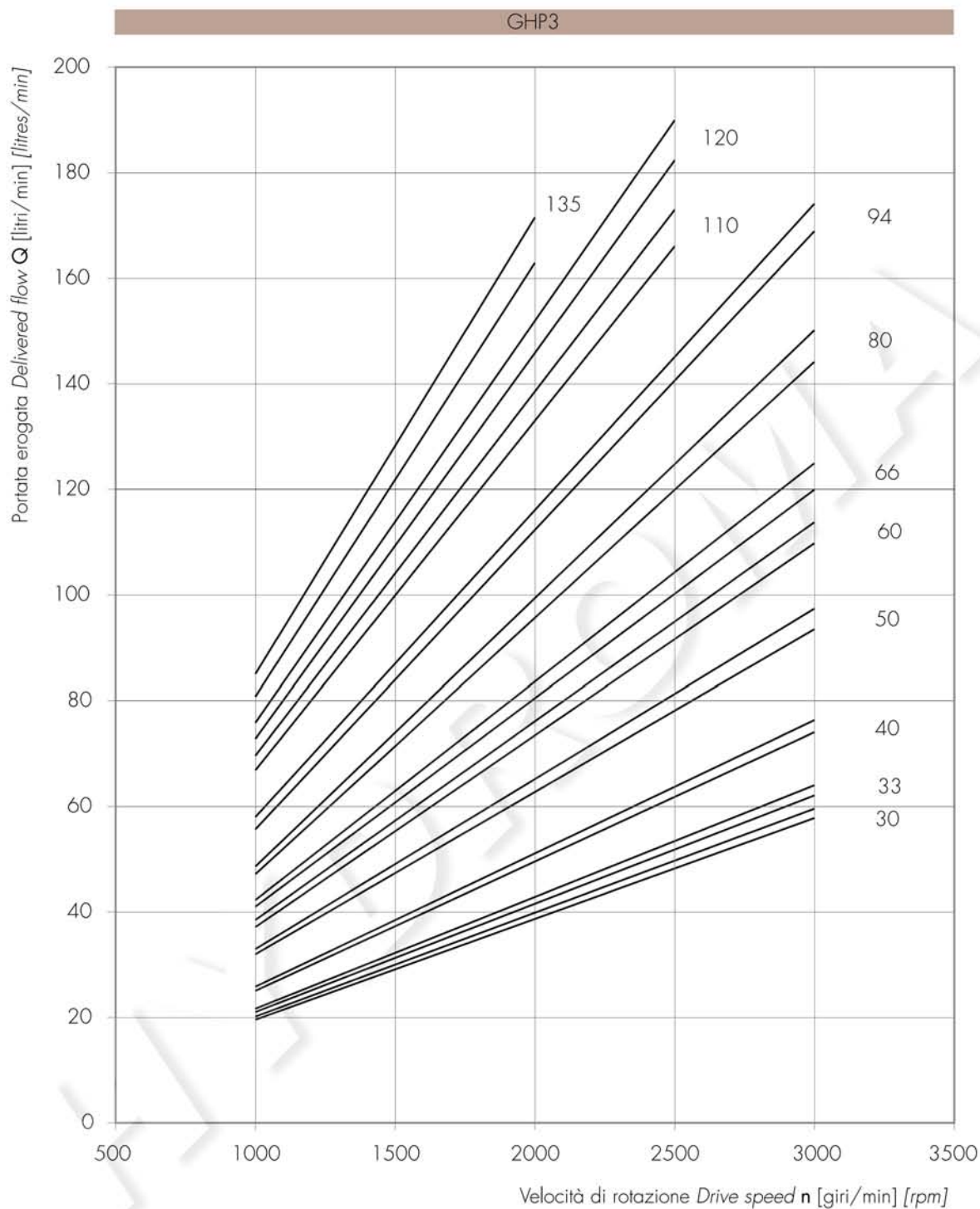

Le curve sono state ottenute alla temperatura di 50°C, utilizzando olio con viscosità 30 cSt alle pressioni sotto riportate.

Each curve has been obtained at 50°C, using oil with viscosity 30 cSt at these pressure.

30
33 — 25-300 bar
40
50
60 — 25-290 bar
66

80 — 25-280 bar
94 — 25-240 bar
110 — 25-220 bar

120 — 25-200 bar
135 — 25-180 bar

Potenza assorbita Absorbed power P [kW]
 Momento torcente assorbito Absorbed torque M [Nm]
 Velocità di rotazione Drive speed n [giri/min] [rpm]

